



## Phase Change Material Based Thermal Storage for Energy Conservation in Building Architecture

www.serd.ait.ac.th/eric

**A. Pasupathy and R. Velraj**  
Department of Mechanical Engineering  
College of Engineering  
Anna University  
Chennai – 600 025  
INDIA  
e-mail: velraj@annauniv.edu

### ABSTRACT

*Efficient and economical technology that can be used to store large amounts of heat or cold in a definite volume is the subject of research for a long time. Thermal storage plays an important role in building energy conservation, which is greatly assisted by the incorporation of latent heat storage in building products. Latent heat storage in a phase change material (PCM) is very attractive because of its high storage density with small temperature swing. It has been demonstrated that for the development of a latent heat storage system (LHTS) in a building fabric, the choice of the PCM plays an important role in addition to heat transfer mechanism in the PCM. Thermal energy storage in the walls, ceiling and floor of buildings may be enhanced by encapsulating or embedding suitable phase change materials (PCMs) within these surfaces. They can either capture solar energy directly or thermal energy through natural convection. Increasing the thermal storage capacity of a building can increase human comfort by decreasing the frequency of internal air temperature swings so that the indoor air temperature is closer to the desired temperature for a longer period of time. This paper aims to submit the information on the developments of PCM incorporation in buildings for energy saving, the problems associated with the selection of phase change material and the various methods used to contain them for space heating and cooling applications*

**Keywords** - Building energy conservation, Encapsulation, Latent heat thermal energy storage, Phase change material, Space heating and space cooling.

### 1. INTRODUCTION

Scientists all over the world are in search of new and renewable energy sources. One of the options is to develop energy storage devices, which are as important as developing new sources of energy. Thermal energy storage systems provide the potential to attain energy savings, which in turn reduce the environment impact related to energy use. Infact, these systems provide a valuable solution for correcting the mismatch that is often found between the supply and demand of energy. Latent heat storage is a relatively new area of study and it received much attention during the energy crisis of late 1970's and early 1980's where it was extensively researched for use in solar heating systems. When the energy crisis subsided, much less emphasis was put on latent heat storage. Although research into latent heat storage for solar heating systems continues, recently it is increasingly being considered for waste heat recovery, load leveling for power generation, building energy conservation and air conditioning applications

As a demand for air conditioning increased greatly during the last decade, large demands of electric power and limited reserves of fossil fuels have led to a surge of interest with efficient energy application.

Electrical energy consumption varies significantly during the day and night according to the demand by industrial, commercial and residential activities. In hot and cold climate countries, the major part of the load variation is due to air conditioning and domestic space heating respectively. This variation leads to a differential pricing system for peak and off peak periods of energy use. Better power generation/distribution management and significant economic benefit can be achieved if some of the peak load could be shifted to the off peak load period that can be achieved by thermal energy storage for heating and cooling in residential and commercial building establishments.

The integration of various intermittent energy sources into a system for heating and cooling eventually necessitates the incorporation of thermal storage. A conceptual illustration of an integrated energy system based on new renewable energy sources with thermal storage is shown in figure 1 which indicates the use of local weather forecasts in order to optimize system efficiency and output by proactive rather than reactive control.

Many phase change materials (PCM's) have been studied/ tested for different practical uses by many eminent scientists. This paper attempts to provide a compilation of much of practical information on different PCMs and systems developed for thermal management in residential and commercial establishments followed by existing systems in use and possible future directions based on latent heat storage technology in building integrated energy system.

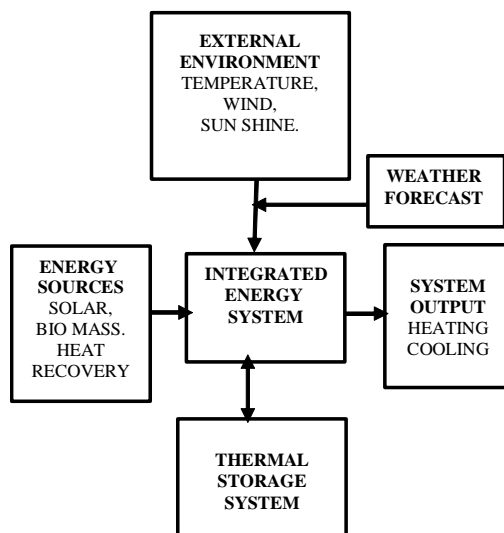

Fig. 1. Concept of integrated energy system with thermal storage.

## 2. DEVELOPMENT OF PCMS FOR HEATING AND COOLING OF BUILDINGS

The application of PCMs in buildings can have two different goals.

- Using natural heat and cold sources, that is solar energy for heating or night cold for cooling.
- Using manmade heat or cold sources.

In any case, storage of heat or cold is necessary to match availability and demand with respect to time and also with respect to power. Basically three different ways to use PCMs for heating and cooling of buildings exist:

- PCMs in building walls
- PCMs in other building components than walls
- PCMs in separate heat or cold stores

The first two are passive systems, where the heat or cold stored is automatically released when indoor or outdoor temperatures rise or fall beyond the melting point. The third ones are active systems, where the stored heat or cold is in containment thermally separated from the building by insulation. Therefore, the heat or cold is used only on demand and not automatically.

Most early studies of latent heat storage focused on the fusion-solidification of low cost, readily available salt hydrates initially showing the greatest promise. Upon phase change, they have a tendency to super cool and the components do not melt congruently so that segregation results. Hence, the phenomena such as super cooling and phase separation often plague the thermal behavior of these materials and cause random variation or progressive drifting of the transition zone over repeated phase-change cycles. Although significant advances were made, major hurdles remained towards the development of reliable and practical storage systems utilizing salt hydrates and similar inorganic substances.

PCMs have not always resolidified properly, because the chemicals in some PCMs separate and stratify when in their liquid state. When temperature dropped, they did not completely solidify, reducing their capacity to store latent heat. These problems have been addressed by packaging phase change material in thin or shallow containers and by adding thickening and clumping agents. These types of PCMs, however, compare unfavorably with the newer generation of low-cost, highly efficient, linear crystalline alkyl hydrocarbons. Researchers now label these older compounds as "limited utility PCMs".

In an effort to avoid some of the problems inherent in inorganic PCMs, an interest has turned towards a new class of materials: low volatility, anhydrous organic substances such as paraffins, fatty acids and polyethylene glycol. Those materials were discarded at first because they are more costly than common salt hydrates and they have somewhat lower heat storage capacity per unit volume. It has now been realized that some of these materials have strong advantages such as physical and chemical stability, good thermal behavior and adjustable transition zone. In building applications, only PCMs that have a phase transition close to human comfort temperature (20°C to 28°C) can be used. Commercial phase change materials have been developed by some of the manufacturers listed in table 1 that are suitable for building applications.

Work is also continuing on integrating PCM into solar photovoltaic modules in order to reduce the operating temperature and thus improving their conversion efficiency. Recent tests have demonstrated temperature reductions of more than 10°C by incorporating a 29°C PCM as a backing of solar modules. This has been achieved by using square metal tubes filled with the PCM. A significant requirement in this research is to develop designs, which maintain good thermal contact between the PCM and the modules in order to facilitate timely heat storage by the PCM during the day and heat loss to the environment during nighttime.

### **3. MICRO AND MACRO ENCAPSULATION METHODS**

Containment costs and attendant problems have been major problems in the earlier development with many of the PCM. The following are the means of PCM incorporation: direct incorporation, immersion and encapsulation. The third one can be defined as the containment of PCM within a capsule of various materials, forms and sizes prior to incorporation so that it may be introduced to the mix in a convenient manner. There are two principal means of encapsulation. The first is micro encapsulation, whereby small, spherical or rod-shaped particles are enclosed in a thin and high molecular weight polymeric film. The coated particles can then be incorporated in any matrix that is compatible with the encapsulating film. It follows that the film must be compatible with both the PCM and the matrix. The second containment method is macro encapsulation, which comprises the inclusion of PCM in some form of package such as tubes, pouches, spheres, panels or other receptacle. These containers can serve directly as heat exchangers or they can be incorporated in building products.

Table 1. Phase Change Temperature and Heat of Fusion of Typical Commercial PCMs

PCM Name	Type of Product	Melting Temp. (°C)	Heat of Fusion (kJ/kg)	Source
Astorstat HA17	(Paraffins and Waxes)	21.7-22.8	-	Astor Wax by Honey well (PCM Thermal Solution)[13]
Astorstat HA18		27.2 - 28.3	-	
RT26	Paraffin	24 - 26	232	Rubitherm GmbH [14]
RT27		28	206	
Climsel C23	Salt Hydrate	23	148	Climator[15]
Climsel C24		24	108	
STL27	Salt Hydrate	27	213	Mitsubishi Chemicals [16]
S27	Salt Hydrate	27	207	Cristopia [17]
TH29	Salt Hydrate	29	188	TEAP [18]
-	Mixture of Two Salt Hydrate	22-25	-	ZAE Bayern[19]
E23	Plus ICE (Mixture of Non-Toxic Eutectic Solution)	23	155	Environmental process system (EPS)[20]

#### 4. PHASE CHANGE MATERIAL APPLICATIONS IN BUILDINGS

There are several promising developments going on in the field of application of PCMs for heating and cooling of buildings. The integration of PCMs in walls and other building component are discussed in the following sections.

##### 4.1 Solar Heat Storage Wall for Building Ventilation

A PCM wall is capable of capturing a large proportion of the solar radiation incident on the walls or roof of a building. Because of the high thermal mass of PCM walls, they are capable of minimizing the effect of large fluctuations in the ambient temperature on the inside temperature of the building. They can be very effective in shifting the cooling load to off-peak electricity period. Arkar and Medved [1] designed and tested a latent heat storage system used to provide ventilation of a building. The spherical encapsulated polyethylene spheres were placed in a duct of a building ventilation system and acted as porous absorbing and storing media. The heat absorbed was used to preheat ambient air flowing into the living space of a building.

The 'solar wall' is another application of PCM for thermal storage. In this case the solar radiation that reaches the wall is absorbed by the PCM 'buried' in the wall. Stritih and Novak [2] designed an 'experimental wall' which contained black paraffin wax as the PCM heat storage agent. The stored heat was used for heating and ventilation of a house. The results of this work, according to the authors, were very promising.

The wall consists of six main components as shown in figure 2. Short wave radiation passes through glass with TIM (Transparent Insulation Material) (1, 2), which prevents convective and thermal radiation heat transfer. Phase change material (3) in a transparent plastic casing made of polycarbonate, absorbs and stores energy mostly as latent heat. The air for the house ventilation is heated in the air channel (4) and it is led into the room. Insulation (5) and plaster (6) are standard elements.

The solar wall has lot of advantages over other systems:

- The high efficiency conversion of solar energy into latent heat is absorption of solar radiation directly into paraffin through transparent plastic glass which is at the same time an insulation material that prevents convective and radiation losses into the surrounding.
- Conductive heat losses from the room are also decreased on the surface where the wall is situated.

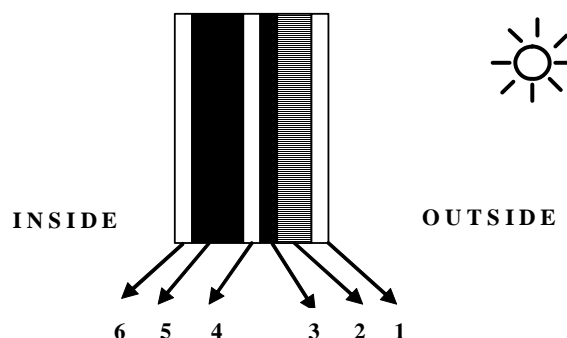

Fig. 2. Elements of PCM solar wall.

#### 4.2 Phase Change Dry Wall Impregnated with PCMS

Phase change dry wall or wallboard is an exciting type of building integrated heat storage material. During the last 20 years, several forms of bulk encapsulated PCM were marketed for active and passive solar applications, including direct gain. However, the surface area of most encapsulated commercial products was inadequate to deliver heat to the building after the PCM was melted by direct solar radiation. The manufacturing techniques, thermal performance and application of gypsum wallboard and concrete block, which have been impregnated with PCMs are discussed by eminent scientists. Gypsum wallboard impregnated with PCM could be installed in place of ordinary wallboard during construction or refurbishment of a building. It will provide thermal storage that is distributed throughout a building, enabling passive solar design and off-peak cooling.

Peippo et al [3] considered a PCM impregnated plasterboard as a storage component in a lightweight passive 120 square meter solar house with good insulation and a large area of south facing glazing in Madison, Wisconsin. The house could save up to 3 GJ in a year or 15% of the annual energy cost. Also, they have concluded that the optimal diurnal heat storage occurs with a PCM having a melting temperature of 1 to 3°C above the average room temperature.

Stetiu and Feustel [4] used a thermal building simulation program based on the finite difference approach to numerically evaluate the latent heat storage performance of PCM wallboard in a building environment. They found that the use of PCM wallboard coupled with mechanical night ventilation in the building offers the opportunity for system downsizing in climates where the outside air temperature drops below 18°C at night. In the case of a prototype building located in California, they estimated that PCM wallboard could reduce the peak-cooling load by 28%

#### 4.3 PCM Integrated in Wood - Light Weight - Concrete

Wood-lightweight-concrete is a mixture of cement, wood chips or saw dust, which should not exceed 15 % by weight, water and additives. This mixture can be applied for building interior and outer wall construction. For integration in wood lightweight concrete, two PCM materials Rubitherm GR 40 and GR 50 were investigated by Mehling et al [5] It was shown that PCMs can be combined with wood-lightweight-concrete and that the mechanical properties do not seem to change significantly.

The authors reported the following advantages.

- Thermal conductivity:  $\lambda$  between 0.15 and 0.75 W/m K
  - Noise insulation
  - Mechanical properties: density between 600 and 1700 kg/m<sup>3</sup>
  - Heat capacity  $c_p$  within 0.39 to 0.48 kJ/kg K at  $\rho = 1300$  kg/m<sup>3</sup>;
  - Density about 60 to 70% of the value of pure concrete (0.67 kJ / kg K at  $\rho = 2400$  kg / m<sup>3</sup>)
- The incorporation of PCM has two additional reasons (1) to increase the thermal storage capacity (2) to get lighter and thinner wall elements with improved thermal performance.

#### 4.4 Thermally Effective Windows with Moving PCM Curtains

Ismail et.al [6] proposed a different concept for thermally effective windows using a PCM moving curtain, as shown in figure 3. The window is double sheeted with a gap between the sheets and an air vent at the top corner. The sides and bottom are sealed with the exception of two holes at the bottom, which are connected by plastic tube to a pump and the PCM tank. The pump is connected in turn to the tank containing the PCM, which is in liquid phase. The pump operation is controlled by a temperature sensor. When the temperature difference reaches a pre-set value the pump is operated and the liquid PCM is pumped out of the tank to fill the gap between the glass panes. Because of the lower temperature at the outer surface the PCM starts to freeze, forming a solid layer that increases in thickness with time and hence prevents the temperature of the internal ambient from decreasing. This process continues until the PCM changes to solid. A well designed window system will ensure that the external temperature will start to increase before the complete solidification of the enclosed PCM.

The proposed concept of the PCM filled window system is viable and thermally effective. It is also confirmed by the authors that the PCM filling leads to filtering out the thermal radiation and reduces the heat gain or losses because most of the energy transferred is absorbed during the phase change of the PCM. The double glass window filled with PCM is more thermally effective than the same window filled with air. The coloured PCM is more effective than in reducing radiated heat gains and that green colour is the most effective of all.

#### 4.5 Roof Integrated Space Heating System

UniSA (University of South Australia) [7] has developed a roof-integrated solar air heating/storage system, which uses existing corrugated iron roof sheets as a solar collector for heating air. A PCM thermal storage unit is used to store heat during the day so that heat can be supplied at night or when there is no sunshine.

The system operates in three modes. During times of sunshine and when heating is required, air is passed through the collector and subsequently into the home. When heating is not required air is pumped into the thermal storage facility, melting the PCM, charging it for future use. When sunshine is not available, room air is passed through the storage facility, heated and then forced into the house. When the storage facility is frozen an auxiliary gas heater is used to heat the home. Adequate amounts of fresh air are introduced when the solar heating system is delivering heat into the home as shown in figure 4.

The authors reported the following advantages.

- The effect of sensible heat is perceived in the initial periods of both melting and freezing. The effect is reflected in sharp increase in the outlet air temperature in the initial periods of melting and a sharp decrease in the initial periods of freezing. For heating purposes, this means a significant warming effect is perceived during the initial periods of delivering air to the living space. This is advantageous from the thermal comfort point of view.
- A higher inlet air temperature increases the heat transfer rates and shortens the melting time. Conversely, during freezing, a lower inlet air temperature increases the heat transfer rates and shortens the freezing time.

- Likewise, a higher air flow rate increases the heat transfer rate and shortens the melting time but increases the outlet air temperature. For freezing, a higher air flow rate increases the heat transfer rate and shortens the freezing time but reduces the outlet air temperature.

#### 4.6 Under Floor Electric Heating System with PCM

Keeping Lina et al [8] put forward a new kind of under-floor electric heating system with shape-stabilized phase change material (PCM) plates. Different from conventional PCM, shape-stabilized PCM can keep the shape unchanged during phase change process. Therefore, the PCM leakage danger

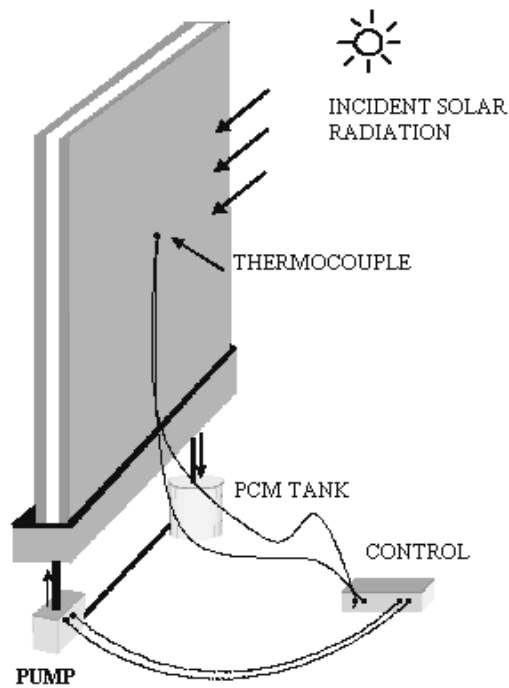

Fig. 3. Layout of the concept of window with movable curtain.

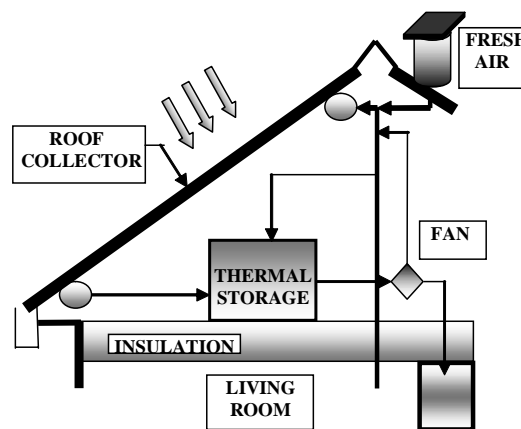

Fig. 4. Schematic of the solar heating system.

can be avoided. This system can charge heat by using cheap nighttime electricity and discharge the heat stored at daytime.

In order to investigate the thermal performance of the under-floor electric heating system with the shape-stabilized PCM plates, an experimental house with this system was set up in Tsinghua University, Beijing, China. The experimental house was equipped with the under-floor electric heating system including shape stabilized PCM plates. The dimensions of the experimental house were 3m (depth) x 2m (width) x 2 m (height). It had a 1.6 m x 1.5 m double-glazed window facing south, covered by black curtain. The roof and walls were made of 100 mm-thick polystyrene wrapped by metal board. The under-floor heating system included 120 mm-thick polystyrene insulation, electric heaters, 15 mm-thick PCM, some wooden supporters, 10 mm-thick air layer and 8 mm-thick wood floor. figure 5 illustrates the structure of the heating system.

The authors illustrated the following conclusions.

- The system increased the indoor temperature without increasing the temperature difference.
- The temperature of the PCM plates was kept at the phase transition temperature for a long period after heaters stopped working. More than half of the total electric heat energy was shifted from the peak period to the off-peak period, which would provide significant economic benefit by different electricity tariff between day and night.
- Small indoor temperature difference along vertical direction appeared because the under-floor heating could warm the indoor air uniformly. The heating system was comfortable and energy-efficient.

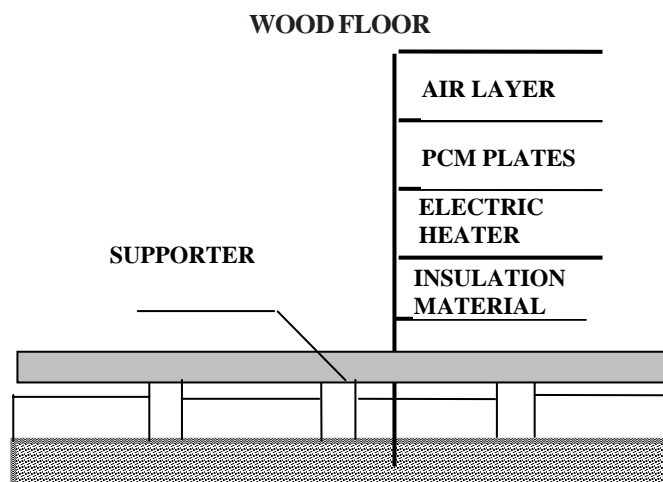

Fig. 5. Schematic of electric floor heating system.

#### 4.7 Free Cooling

Free cooling was investigated at the University of Zaragoza / Spain by B. Zalba. [9]. The objective of the work was to design and construct an experimental installation to study PCMs with a melting temperature between 20 to 25°C as shown in figure 6. This temperature range is thought to be the most suitable for free cooling as night time outside temperatures usually fall below and as this temperatures are still low enough to cool air in buildings. Free cooling installation to store outdoors cold during night and release it indoors during day. This concept is feasible in climates where the temperature difference between day and night in summer is over 15°C.



The approach at the University of Nottingham [10] is a replacement of a full air conditioning system by the new system that is a nighttime cooling system, which is also easy to retrofit. The proposed module is shown in figure 7. It is ceiling-mounted with a fan to throw air over the exposed ends of heat pipes. The other end of the heat pipes is in a PCM storage module. During the day, the warm air generated in the room is cooled by the PCM i.e. heat is transferred to the PCM. During the night, the fan is reversed and the shutters are opened such that cool air from the outside passes over the heat pipes and extracts heat from the PCM. The cycle is then repeated next day.

The melt and freeze temperatures of the PCM are approximately 22°C and 20°C respectively. Complete melting occurs over a period of about 8 hours when the temperature difference between the PCM and the air is 2°C and over a period of about 3 hours is 3.5°C. The heat transfer rates are 80 W and 200 W per unit respectively or 800 W and 2000 W for a room with 10 units.

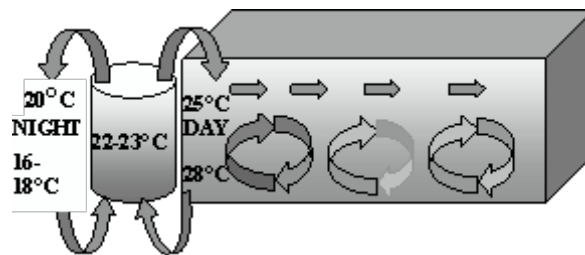

Fig. 6. Concept of free cooling.

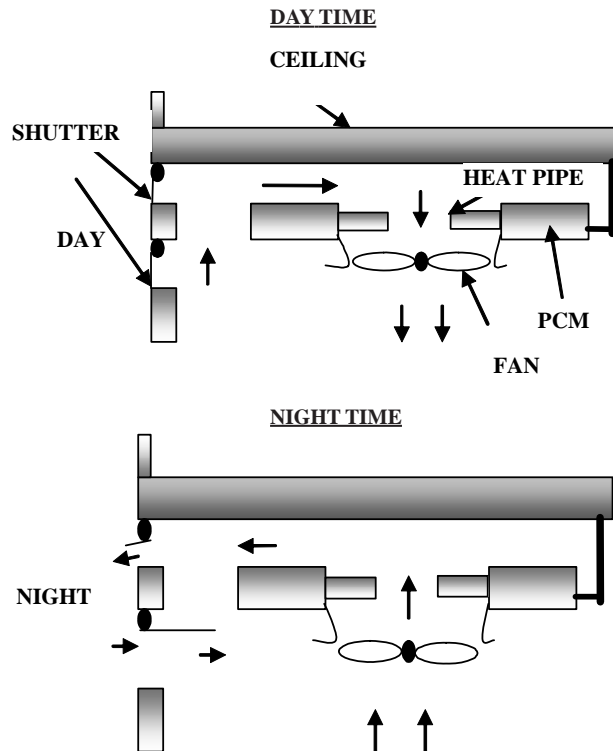

Fig. 7. System design as proposed by the University of Nottingham.

#### 4.8 PCM Integrated in Combined Heating and Cooling System

The Sustainable Energy Centre (SEC) at University of South Australia [11] started work with PCMs in the mid 1990's with the development of a storage unit that can be used for both space heating and cooling. The night time charging and day time utilization process during both heating and cooling seasons for a storage system comprising of two different PCMs integrated into a reverse cycle refrigerative heat pump system utilizing off peak power. As the air is forced through the system it undergoes a two-stage heating or cooling process. It first goes through one PCM and then the second as shown in figure 8.

The melting / freezing point of the first material are below comfort temperature, while the second material has a melting/freezing point above comfort temperature. During the winter, the airflow is adjusted so that the system stores heat at night (by both materials melting) and releases heat at a temperature above comfort conditions (by freezing) at daytime. During summer, the airflow direction is reversed and the system stores cold energy at night and it releases the cool air below comfort temperature at daytime. The amount of reduction in the required capacity for the air conditioner and the amounts of the heating and cooling loads transferred to off peak hours were reported by them using the computer model for the storage system. Annual energy cost savings is also provided by them. Using a thermal storage system containing two different PCMs can reduce the required capacity and the initial cost of air conditioner for a residential house. It also can shift a portion of the heating and cooling loads to off peak hours, when electricity cost is lower. The calculations for a typical house in Adelaide showed that a storage system consisting of 100 kg of 29°C PCM and 80kg of 18°C PCM reduced the nominal rate of the air conditioner required by 50% of total load. Also the annual electricity cost was reduced by 32% due to shifting the load to off peak time. The utility company could benefit by the shift of 52% and 41% of the air conditioning loads during the cold and the warm seasons by reduced generation and transmission capacities if the proposed storage system is used on a large scale.

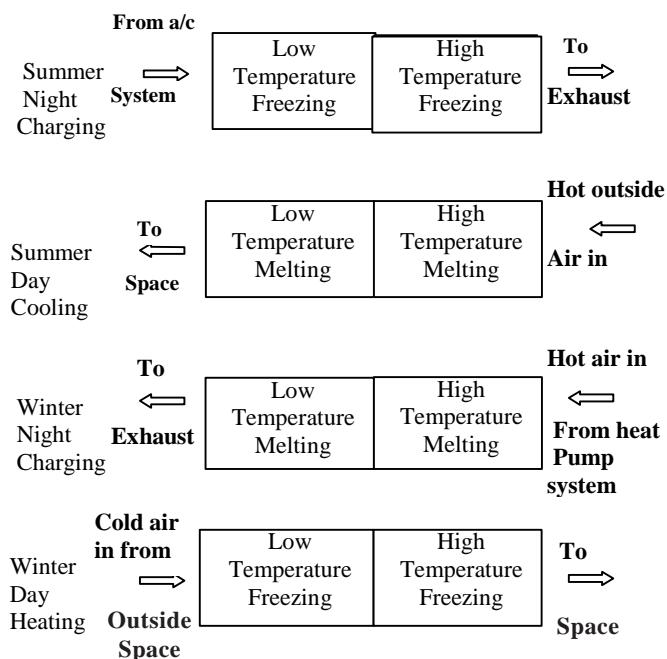

Fig. 8. Night-time charging and day-time utilization process during both heating and cooling seasons.

### 4.9 PCM Based Storage System for Building Air-Conditioning

Velraj et al., [12] presented a detailed study on PCM based Cool Thermal Energy Storage (CTES) integrated with building air conditioning system in Tidel Park, Chennai, India. The Tidel Park is a software office complex with twelve storeys and a building carpet area of about 92900 square meters. The storage system in Tidel Park is the largest in the south Asia region and third largest in the world. Their study has been made on the existing large PCM based cool storage, which is 24,000TRH (303840 MJ) integrated with a 3000 TR (10550 kW) chillers system. The total capacity is split into four parallel paths by chiller banks A, B, C, and D each comprising 750 TR. Each of the 750 TR capacity chiller banks is provided by 3 number of 250 TR units. One such 250 TR unit is shown in figure 9. All the chiller banks of air conditioning unit are connected to three Plate Heat Exchangers (PHE) of each 2000 TR capacity. The installed capacity of the Cool Thermal Energy Storage (CTES) system is 24,000 TRH. This is provided by four cool energy storage tanks each of 6000 TR capacity. Of these, one tank is kept as standby and all the tanks are connected in parallel to the three plate heat exchangers. The plate heat exchanger receives cold heat transfer fluid (Brine solution) from the chiller / CTES system and transfers the energy to the chilled water which in turn transfers the energy to the air in the Air Handling Unit (AHU). The modes of operation of such a system for load management have been discussed in detail in their study.

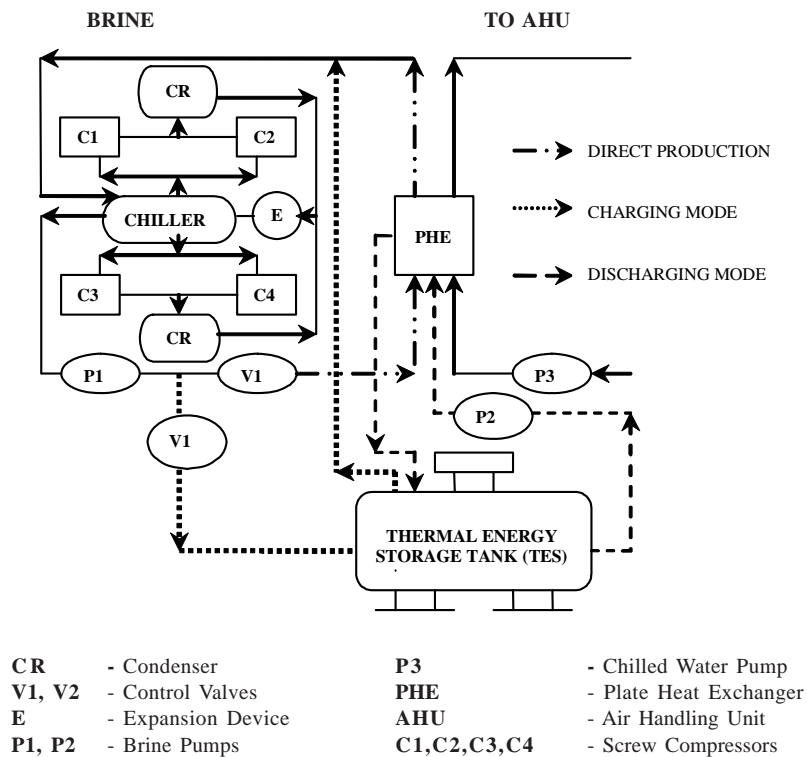

Fig. 9. Layout of air-conditioning system using thermal energy storage.

- The major advantages of this cool storage system are
- (i) Peak cooling load demand can be reduced. In the present case the cool thermal energy storage capacity of 24,000 TRH reduced the installation requirement of centralized air-cooled vapour compression air conditioning system from 6000 TR to 3000 TR. This reduces the electricity demand by approximately 4000 kVA. The power distributor (Tamilnadu Electricity Board, India) charges INR

300/kVA/month and hence there is a saving in demand charge of INR 14.4 million /year (4000 x 300 x 12months) achieved due to this cool thermal storage.

- (ii) The tariff difference during peak hours and off peak hours can be exploited.
- (iii) The performance of the chiller plant is high if the system is operated during the night hours when the surrounding temperature is low. The CTES system can be charged during the night hours and the stored energy can be retrieved during the daytime.
- (iv) Chiller plant can be operated always under full load condition and hence the efficiency of the system is high
- (v) Diesel generator set operation can be avoided for air-conditioning load during the power failure.

The authors suggested that the CTES system can be introduced economically for air conditioning in residential / commercial establishments.

## 5. CONCLUSION

Several promising developments are taking place in the field of thermal storage using PCM's in buildings. In the present paper, a detailed study on PCM incorporation in building material, PCMs integration with building architecture for space heating, space cooling and in combination of heating and cooling has been carried out. It is quite evident from the preceding reviews that the thermal improvements in a building due to the inclusion of PCMs depend on the melting temperature of the PCM, the type of PCM, the percentage of PCM mixed with conventional material, the climate, design and orientation of the construction of the building. The optimization of these parameters is fundamental to demonstrate the possibilities of success of the PCMS in building materials. Therefore, the information like operational range and limitations evolved in a project with PCM's as heat transport medium and elaborate calculation for analysis supported by a simulation programme would definitely be a remarkable and reckonable guidance for deciding and designing PCMs in building application. A passive PCM based thermal storage system can face problems if space is a consideration, and hence future directions of research have to be in the development of active based PCM systems which integrate PCM into the building material or structure. The integration of separate cool thermal energy storage integrated with air-conditioning system seems to be very promising for multistoried residential and commercial establishments.

## 6. NOMENCLATURE

C <sub>p</sub>	Specific heat capacity (J/kg K)
K	Kelvin.
kg	Kilogram.
kJ	Kilo Joule.
kVA	Kilo Volt-Ampere
MJ	Mega-Joule
TR	Ton of Refrigeration. (1 TR = 3.5 kW)
TRH	Ton of Refrigeration Hours. (1 TRH = 12660 kJ)
$\lambda$	Thermal Conductivity (W/m K)
$\rho$	Density (kg/m <sup>3</sup> )

## 7. REFERENCES

- [1] Arkar, C. and Medved, S. 2002. Enhanced solar assisted building ventilation system using sphere encapsulated PCM thermal heat storage. IEA, ECES IA Annex 17, Advanced thermal energy Storage

- Techniques – Feasibility Studies and Demonstration Projects 2<sup>nd</sup> Workshop, Ljubljana, 3 – 5 April, Slovenia.
- [2] Stritih, U. and Novak, P. 2002. Thermal storage of solar energy in the wall for building Ventilation. Second workshop: IEA, ECES IA Annex 17, Advanced thermal energy storage techniques - Feasibility studies and demonstration projects, Ljubljana, 3 - 5 April, Slovenia.
- [3] Peippo, K.; Kauranen, P.; and Lund, P.D. 1991. A Multicomponent PCM Wall Optimized for Passive Solar Heating, *Energy Buildings* 17: 259 - 270.
- [4] Stetiu, C. and Feustel, H.E. 1998. Phase Change Wallboard and Mechanical Night Ventilation in Commercial Buildings, Lawrence Berkeley National Laboratory.
- [5] Mehling, H.; Krippner, R.; and Hauer, A. 2002. Research project on PCM in wood-lightweight-concrete”, IEA, ECES IA Annex 17, Advanced thermal energy storage through phase change materials and chemical reactions - feasibility studies and demonstration projects. 2nd Workshop, Ljubljana, 3-5 April, Slovenia
- [6] Ismail, K.A.R. and Henriquez, J. R.2001. Thermally Effective Windows with Moving Phase Change Material Curtains, *Applied Thermal Engineering* 21: 1909-1923.
- [7] Saman, W.Y. and Belusko, M. 1997. Roof Integrated Unglazed Transpired Solar Air Heater. *Proceedings of the 1997 Australian and New Zealand Solar Energy Society*, Lee T. (Ed). Paper 66, Canberra, Australia.
- [8] Kunping Lin.; Yinping Zhang.; Xu Xu.; Hongfa Di.; Rui Yang.; and Penghua Qin. 2005. Experimental study of under-floor electric heating system with shape-stabilized PCM plates, *Energy and buildings* 37: 215-220.
- [9] Belen Zalba.; Jose M Marín.; Sánchez-Valverde.; and Luisa.F. Cabeza. 2002. Free-cooling. An application of PCMs in TES, *Proceedings of the 3rd workshop of IEA ECES IA Annex 17, Tokyo (Japan)*.
- [10] University of Nottingham, <http://www.nottingham.ac.uk/sbe/research/ventcool/objectives.htm>,2002.
- [11] Vakilaltojjar. S and Saman. W. 2000. Domestic Heating and Cooling with Thermal Storage. 8th International Conference on Thermal Energy Storage, 28 August - 1 September 2000, Stuttgart, Germany, pp. 381-386.
- [12] Velraj R.; Anbudurai K.; Nallusamy N.; and Cheralathan. M. 2002, “PCM based thermal storage system for building air conditioning at Tidel Park, Chennai”, WREC Cologne. *Proceedings*
- [13] Nagano K; Mochida T; Takeda S; Domanski R; and Rebow M. 2003, Thermal characteristics of manganese (II) nitrate hexa-hydrate as a phase change material for cooling systems, *Applied thermal engineering* 23, 229-241.
- [14] Available from [www.rubitherm.de](http://www.rubitherm.de).
- [15] Available from [www.climator.com](http://www.climator.com).
- [16] H. Kakiuchi, Mitsubishi Chemical Corporation, private communication, 2002.
- [17] Available from [www.cristopia.com](http://www.cristopia.com).
- [18] Available from [www.teappcm.com](http://www.teappcm.com).
- [19] Belen Zalba.; Jose M Marín.; Luisa.F. Cabeza; Harald Mehling, 2004. Free-cooling of buildings with phase change material, *International Journal of Refrigeration* 27, 839- 849.
- [20] Available from, [www.eps ltd.co.uk](http://www.eps ltd.co.uk).

