

Studies of Bare and Glass-Cover Flat-Plate Solar Air Heaters

Somchart Soponronnarit

Associate Professor
School of Energy and Materials
King Mongkut's Institute of Technology Thonburi
Bangkok, Thailand

Watcharasak Subannapong and Jirawan Tiansuwan

Formerly master degree students in the Energy Technology Program
School of Energy and Materials
King Mongkut's Institute of Technology Thonburi
Bangkok, Thailand

ABSTRACT

A short review of solar drying is presented at the outset of the paper. Then the author's research is dealt with in the remainder of the paper. Bare and transparent-cover flat-plate solar air heaters were developed by modifying the roof of a building. They were then tested. A mathematical model for predicting thermal efficiency under steady conditions was developed. Guidelines for selecting solar air heaters and air speed inside the solar collector are given. Finally, an economic analysis was carried out and the results presented in detail.

INTRODUCTION

A solar air heater may be defined as a device which converts solar radiation into heat in terms of increasing enthalpy of air. The device is usually very simple. It comprises an absorber which acts as an energy converter, air channel, and clear top cover as an option. While air is flowing through the air channel in the device, heat is extracted from the absorber to the air, resulting in a temperature rise or, in other words, hot air is obtained. The hot air may be used for space heating or drying. Given Thailand's hot and humid climate opportunities for space heating are extremely limited. However, this is not the case with drying by means of a solar air heater. The potential for accepting solar air heaters in the near future is relatively high and they may become as popular as the solar water heater, for which a local market now exists.

Foster and Peart (1976) summarized the current research and development work on solar grain drying in the United States of America. Several types of solar air heater have been developed and tested. They may be classified broadly into three categories.

1. flat-plate solar air heaters;
2. non flat-plate solar air heaters; and
3. integrated collector-storage heaters.

A flat-plate solar air heater usually has a surface area of about 2 square metres. When a large area of solar collector is needed, several flat plates are then connected together. A flat-plate solar air heater may consist of an absorber for converting solar radiation into heat in terms of increasing

enthalpy of air, an air channel through which air flows and extracts heat from the absorber, a top transparent cover and bottom insulation for preventing heat loss, both of which are optional. Figure 1 shows three general types of flat-plate solar air heaters namely: a) bare flat-plate; b) transparent-cover flat-plate without still air gap; and c) transparent cover flat-plate with still air gap. The bare flat-plate solar air heater (Fig. 1 a) is the simplest and cheapest but the thermal efficiency, which depends strongly upon wind speed above the solar collector, is the lowest. Thermal efficiency is improved when the solar air heater is fabricated in the form of a transparent cover flat-plate without still air gap (Fig. 1 b). Fabrication is a bit more difficult and the cost is a bit higher. Thermal efficiency is even higher when a still air gap is introduced as shown in Fig. 1 c. However, its fabrication is the most difficult and its cost is the highest among the three types.

Flat-plate solar air heaters may be fabricated in modules and then installed on the ground or on a building roof. Roofs and walls of buildings can also be modified so that they become solar air heaters. In this case, the cost can be significantly reduced. For regions having low degree of latitude like Thailand, the installation of a solar air heater on vertical walls may not be appropriate because transmission and absorption may not be effective and this results in low thermal efficiency.

For regions in the northern hemisphere, flat-plate solar air heaters should be facing south. Deviation from the south may be plus or minus 30 degrees without significant loss in total solar radiation. Inclination angle of the flat plate is usually equal to latitude or about 0.9 times latitude. However, it may deviate from the latitude by about plus or minus 15 degrees without significant loss in total solar radiation.

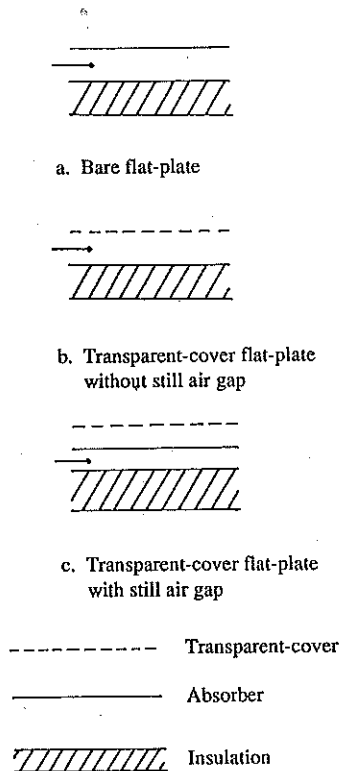

Fig. 1. Section in profile of typical flat-plate solar air heaters.

Non flat-plate solar air heaters are air heaters constructed from plastic film which may or may not be inflated and which do not have a flat shape. Figure 2 shows some typical designs of inflated solar air heaters. This type of solar collector has the following advantages: its cost is low, it is easy to construct and can be kept off-site when not in use. However, rapid degrading of the plastic film seems to be a serious problem. Inflated solar air heaters are usually installed in the form of a long air channel. They can have an east-west or a north-south orientation.

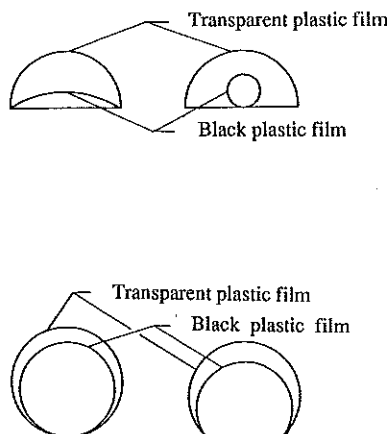

Fig. 2. Cross-section of typical inflated solar air heaters.

The last type of solar air heater mentioned is the integrated collector-storage type. It consists of a solar collector and a rock heat storage connected together in series. Heat storage functions as a temperature regulator. When drying certain products, however, regulation of temperature may not be critical. Heat storage is hence not suggested. Soponronnarit and Peyre (1982) compared, experimentally, the solar drying of sorghum without and with rock heat storage connected in series. Results indicated that drying rates for the two cases were not different. Therefore, heat storage was not suggested. It was also concluded by experts during a meeting on solar drying at the FAO office in Bangkok that rock heat storage was not considered viable (Anon, 1986).

In Thailand some research and development work on solar drying has been conducted. Most of the solar air heaters developed have been the flat-plate type and were aimed for agricultural drying purposes (Soponronnarit, 1988).

Thongprasert et al. (1985) conducted research on solar paddy drying. Drying air was heated by a 3.74 m wide x 4.48 m long solar air heater. Cross-section of the solar air heater is shown in Fig. 3. Air flowed through the solar air heater, between a glass cover and an absorber. With an air flow rate of 0.82 kg/s, the thermal efficiency varied from 40 to 70%. Drying results indicated that solar paddy drying was technically and economically viable.

Solar-assisted curing of tobacco leaves was developed by Boonlong et al. (1984). The experimental prototype system consisted of a 3.6 m x 3.6 m x 4.8 m scaled-down (1:4 scale) tobacco curing barn with 1 ton fresh leaves loading capacity, an array of 38.5 m² flat-plate solar air heaters (Fig. 4) and a 6 m³ rock-bed unit. Forced convection was induced through the system by two blowers. Test results indicated that solar-assisted curing of tobacco leaves was technically viable. Based on the benefits received from LPG fuel saving, Sitthiphong (1987) showed that the

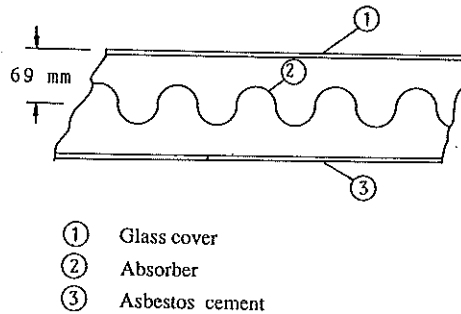

Fig. 3. Cross-section of the solar collector developed by Thongprasert et al. (1985) (perpendicular to the direction of air flow).

benefit/cost ratio of the above solar-assisted tobacco curing was 0.63. This ratio increased to 1.34 when longan fruit was dried in the same dryer.

Solar air heaters which were integrated in natural convection solar dryers have also been investigated in Thailand. These were plastic film solar air heaters used in an AIT solar rice dryer (Exell, 1980), and a flat-plate solar air heater in a cabinet solar dryer (Thaina 1979, Patranon, 1984). Due to natural convection of air through the solar air heater, air flow rate varies. Hence, thermal efficiency varies throughout the day. Solar collecting efficiency is usually less than that of forced convection.

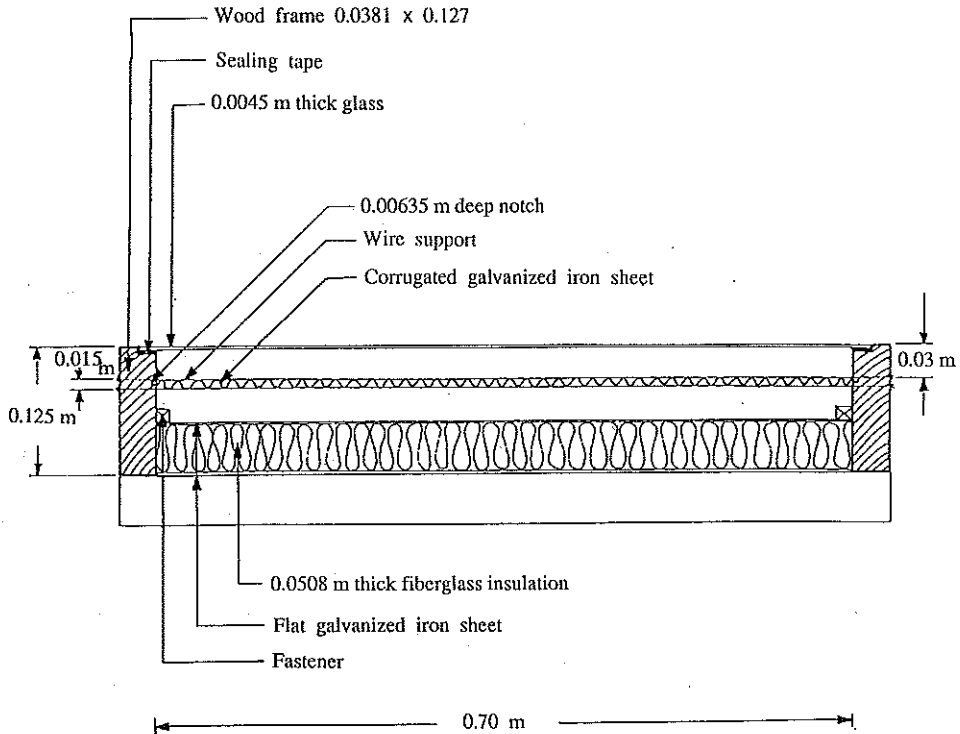

Fig. 4. Cross-sectional view of solar air heater (Boonlong et al., 1984).

THE RESEARCH

The research presented in this paper dealt with the forced-convection flat-plate type of solar air heaters which are used for agricultural drying. These are bare and glass-cover flat-plate solar air heaters. The development of these units involves modifying building roofs into solar air heaters. The specific objectives of the research were to:

- develop a mathematical model for predicting steady state thermal performance of solar air heaters;
- develop low cost solar air heaters;
- offer guidelines for selecting solar air heaters and the appropriate air speed inside the solar collector; and
- evaluate solar air heaters technically and economically.

PROCEDURE

Development of Mathematical Models

Figures 5 and 6 show the details of bare and transparent-cover type flat-plate solar air heaters and their thermal networks. At steady conditions three equations based on energy balance (the same for both cases) can be formulated.

$$S + h_1 (T_f - T_p) + U_i (T_a - T_p) + h_r (T_i - T_p) = 0 \quad (1)$$

$$-q_u + h_1 (T_p - T_f) + h_2 (T_i - T_f) = 0 \quad (2)$$

$$h_2 (T_f - T_i) + U_b (T_a - T_i) + h_r (T_p - T_i) = 0 \quad (3)$$

in which

- S = absorbed solar radiation at the absorbing plate, W/m^2
- q_u = useful energy, W/m^2
- U_i = top loss coefficient, W/m^2K
- U_b = bottom loss coefficient, W/m^2K
- h_1 = convective heat transfer coefficient between the absorber and the flowing air, W/m^2K
- h_2 = convective heat transfer coefficient between the insulation and the flowing air, W/m^2K
- h_r = radiation heat transfer coefficient between the absorber and the insulation, W/m^2K
- T_i = temperature of insulation, $^{\circ}K$
- T_f = temperature of flowing air, $^{\circ}K$
- T_a = ambient temperature, $^{\circ}K$
- T_p = temperature of absorber, $^{\circ}K$

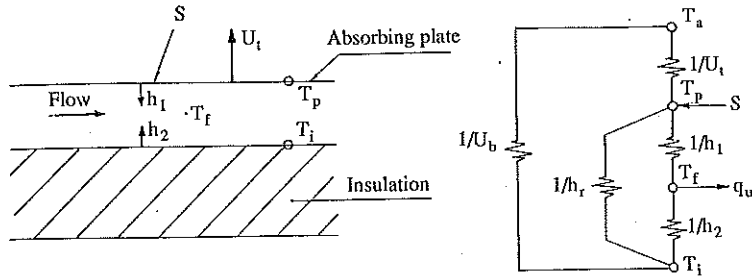

Fig. 5. Section of bare flat-plate solar air heater and thermal network.

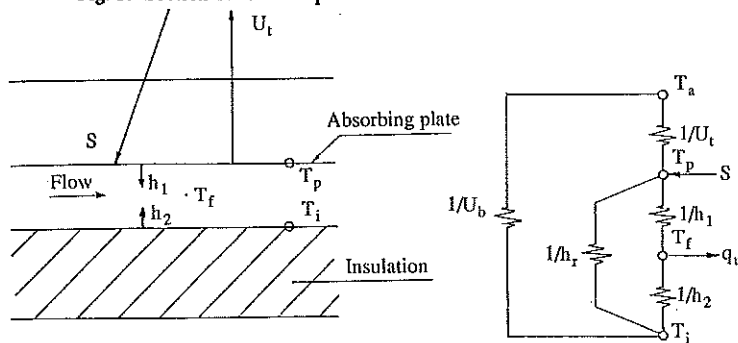

Fig. 6. Section of glass-cover flat-plate solar air heater and thermal network.

Rearranging for useful energy, q_u , from the above equations and assuming $h_1 = h_2 = h$, one gets

$$q_u = F' [S - U_L (T_f - T_a)] \quad (4)$$

in which

$$F' = \frac{h^2 + 2h h_r + h U_b}{(h + h_r + U_t)(h + h_r + U_b) - (h_r)^2} \quad (5)$$

$$U_L = \frac{(U_b + U_t)(h^2 + 2h h_r) + 2U_b U_t h}{h^2 + 2h h_r + h U_b} \quad (6)$$

It will be more convenient if the relationship between useful energy, q_u , and inlet air temperature, T_{fi} , is employed instead of useful energy, q_u , and temperature of the flowing air, T_f . The equation can be written as follows:

$$q_u = F_R [S - U_L (T_{fi} - T_a)] \quad (7)$$

Duffie and Beckman (1980) determined F_R by assuming that F' and U_L were independent of the position of a collector, then

$$F_R = (\dot{m} C_p / A_c U_L) (1 - e^{-(A_c U_L F' / \dot{m} C_p)}) \quad (8)$$

where \dot{m} , C_p , and A_c are mass flow rate (kg/s), specific heat of air (J/kgK), and collector area (m²), respectively.

Thermal efficiency of solar collector, η , is defined as the ratio of useful energy to solar radiation incident on the plane of the collector, G_T .

$$\eta = q_u / G_T \tag{9}$$

$$\text{or } \eta = F_R (\tau\alpha)_e - F_R U_L (T_{fi} - T_a) / G_T \tag{10}$$

where $(\tau\alpha)_e$ is effective transmittance-absorptance product. In the case of a bare plate solar collector, $(\tau\alpha)_e$ is equal to α .

To obtain values of F' and U_L , it is necessary to determine heat transfer coefficients, U_i , U_b , h , and h_r . These can be calculated by employing a knowledge of heat transfer.

The top loss coefficient, U_i is composed of two heat transfer coefficients, i.e., convection due to wind and radiation. Watmuff et al. (1977), as quoted in Duffie and Beckman (1980), gives the relationship between the coefficient of convection loss due to wind, h_w , (W/m²K) and wind speed, V , (m/s) as the following:

$$h_w = 2.8 + 3.0 V \tag{11}$$

Design of Solar Air Heaters

Characteristics of a low cost solar air heater were first defined in order to provide a basis for designing appropriate solar air heaters. They were as follows:

1. It should be composed of a minimum amount of materials.
2. Materials should be properly selected so that they are cheap and locally available.
3. Construction should not be too complicated in order to allow farmers to build solar air heaters by themselves.

To accommodate the above requirements, a building roof was successively modified into various type of solar air heaters. Figure 7 shows a perspective view of a small hut having a 19 m² roof area made from sinusoidal corrugated galvanized iron sheet. Styrofoam of 25 mm thickness was held in place with an average spacing of 20 mm under the corrugated galvanized iron sheet by plywood of 4 mm thickness (Figs. 8 and 9). Air flowed downwards by the aid of a blower driven by an electric motor. In this manner, it was expected that natural convection of hot air would take place when the blower was not in operation. As a result, air temperature in the gap would not become high enough to damage the styrofoam.

To improve the efficiency of the solar collector, the sinusoidal corrugated galvanized iron sheet was painted dull black. It was then partially covered (85 %) with clear glass sheets having 25 mm still air gap in order to improve its thermal efficiency (Figs. 10 and 11). The reason for partial covering was to have some free space for climbing so that repair and maintenance could be carried out easily. Due to the difficulty of installing a clear glass-cover on sinusoidal corrugated galvanized iron sheet, trapezoidal corrugated galvanized iron sheet was used instead in order to simplify the construction work. The covered surface area was 87.5% (Fig. 12). In the final stage, the roof was fully covered with clear glass sheets as shown in Fig. 13.

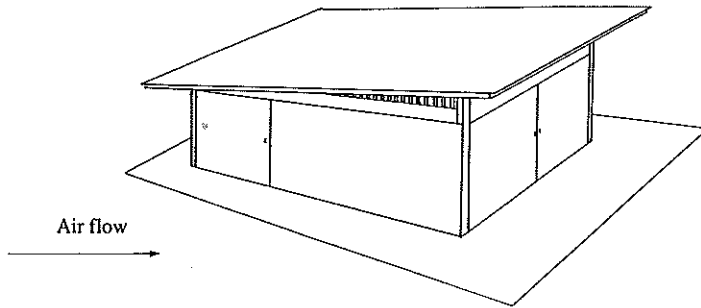
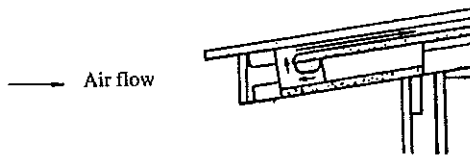

Fig. 7. Perspective view of bare flat-plate solar air heater on the top of building.



Detail A

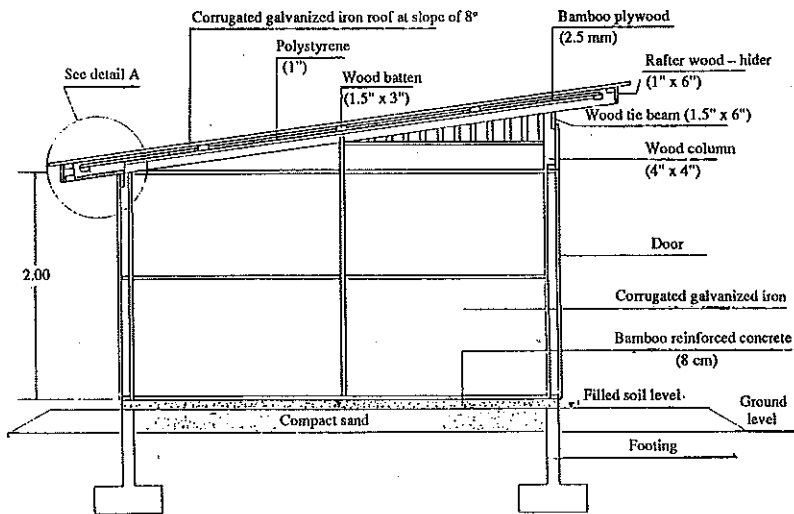

Fig. 8. Section in profile of bare flat-plate solar air heater.

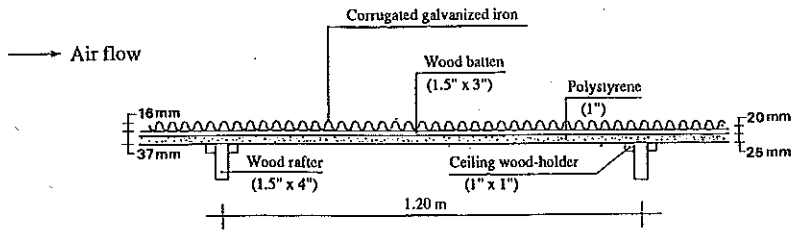

Fig. 9. Cross-section of bare flat-plate solar air heater (perpendicular to air flow).

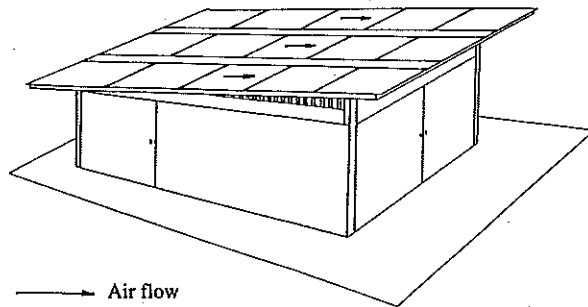

Fig. 10. Perspective view of glass-cover (85%) flat-plate solar air heater on the roof of building.

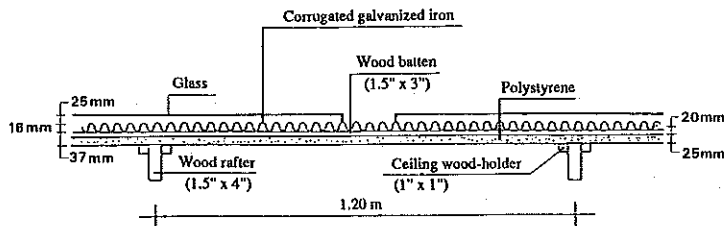

Fig. 11. Cross-section of glass-cover (85%) flat-plate solar air heater (sinusoidal shape).

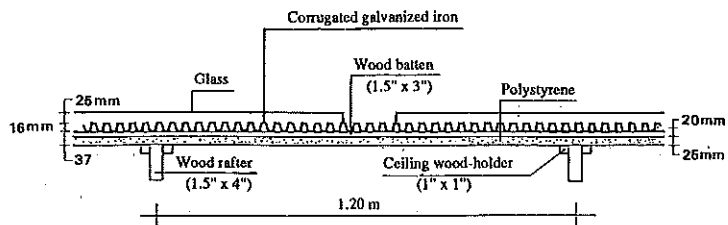

Fig. 12. Cross-section of glass-cover (87.50%) flat-plate solar air heater (trapezoidal shape).

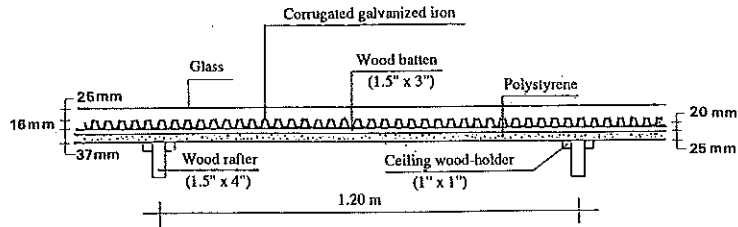

Fig. 13. Cross-section of full glass-cover flat-plate solar air heater (trapezoidal shape).

Test Procedures

Test procedures of the various solar air heaters tested followed the standard of ASHRAE 93-77 (Anon, 1977). However, there were some differences between the test procedures and that of ASHRAE. This was due to the limited amount and accuracy of measuring instruments. For example, solar radiation on a horizontal surface was measured instead of radiation on an inclined surface. The accuracy of temperature measurements was lower than that suggested by ASHRAE.

During the test of each solar collector, air was forced to flow upward in order to facilitate the test. A forward curved blade centrifugal fan driven by a 373 W electric motor was employed to deliver air through an electrical heater, duct system, and solar collector, respectively. Inlet air temperature at the entrance of the collector was controlled by a thermostat.

Ambient temperature, air temperature at the inlet (4 points) and at the outlet (4 points) were measured by an Iron Constant thermocouple and recorded by a data logger (model : Doric 205). Accuracy was approximately $\pm 1^\circ\text{C}$ with repeatability of 0.1°C . Recording was done every six minutes and the average value over a 30 minutes interval was used in calculation.

The air velocity profile in the duct was measured by a pitot tube. The air flow rate was the product of the average velocity and the duct cross-sectional area.

Wind velocity above the solar collector was measured by a cup anemometer. Readings were done instantaneously. Wind velocity was normally less than 1 m/s.

Global solar radiation was measured by a solar pyranometer and integrator (Kip and Zonnen, model : CC 12). It had an accuracy of $\pm 0.1\%$. This measured value was employed for calculating the thermal efficiency of the solar collector. It was found by computation that solar radiation on a horizontal surface, G , and on the surface of the solar collector, G_T , were not much different.

Testing was done between 10:30 A.M. and 14:30 P.M. for clear sky conditions. Inlet air temperature was allowed to vary at least for four or five different values. At each temperature, the solar collector was heated for about 30 minutes, in order to obtain a nearly steady condition, before taking data.

RESULTS AND DISCUSSIONS

Collector Test

Five types of flat-plate solar air heaters were tested according to ASHRAE Standard 93-77. All of them had a 3.70 m wide x 5.09 m long absorber (18.83 m^2) which was tilted 8 degrees facing toward the south. Average spacing between the absorber and insulation which formed the air passage was 20 mm. Descriptions of these solar collectors are presented as follows:

1. *Bare flat-plate solar air heater*: The absorber was sinusoidal corrugated galvanized iron

sheet having absorptivity and emissivity measured by spectrophotometer equal to 0.69 and 0.64, respectively.

2. **Bare flat-plate solar air heater painted dull black:** The absorber was sinusoidal corrugated galvanized iron sheet painted dull black. The absorptivity and emissivity measured by spectrophotometer were 0.94 and 0.84, respectively.
3. **Partial glass-cover flat-plate solar air heater having sinusoidal shape absorber:** The absorber was similar to the 2nd type but it was 85% covered with clear glass sheet. The absorptivity and emissivity measured by spectrophotometer were 0.94 and 0.89, respectively.
4. **Partial glass-cover flat-plate solar air heater having trapezoidal shape absorber:** This type of collector was similar to the 3rd type. The absorber had trapezoidal shape and was 87.5 % covered by clear glass sheets. The absorptivity and emissivity measured by spectrophotometer were 0.95 and 0.89, respectively.
5. **Full glass-cover flat-plate solar air heater:** It was similar to the 4th type but fully covered with clear glass sheets.

Results of collector tests are presented in Figs. 14-18 and then summarized in Table 1. The relationship between thermal efficiency and $(T_{fi} - T_a)/G$ was linear, i.e. efficiency decreased when $(T_{fi} - T_a)/G$ increased. It was obvious that solar air heaters with transparent covers performed better than bare plate solar air heaters in terms of higher $F_R (\tau\alpha)_e$ and smaller $F_R U_L$. Wind speed during the test was equal to or less than 1 m/s. If it had been higher, the difference in performance

Table 1. Results of collector test.

Type	\dot{m} (kg/s)	$F_R (\tau\alpha)_e$	$-F_R U_L$ (W/m ² K)	Correlation Coefficient	Standard Error Estimate
1	0.34	0.29	-7.96	0.812	0.054
2	0.23	0.32	-9.34	0.963	0.029
3	0.24	0.47	-5.50	0.973	0.002
4	0.24	0.48	-7.25	0.977	0.001
5	0.24	0.49	-7.13	0.932	0.004

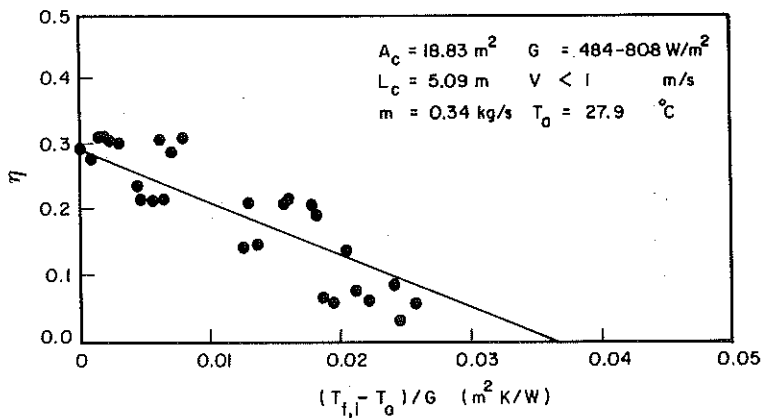

Fig. 14. Test result of bare flat-plate solar air heater without painting.

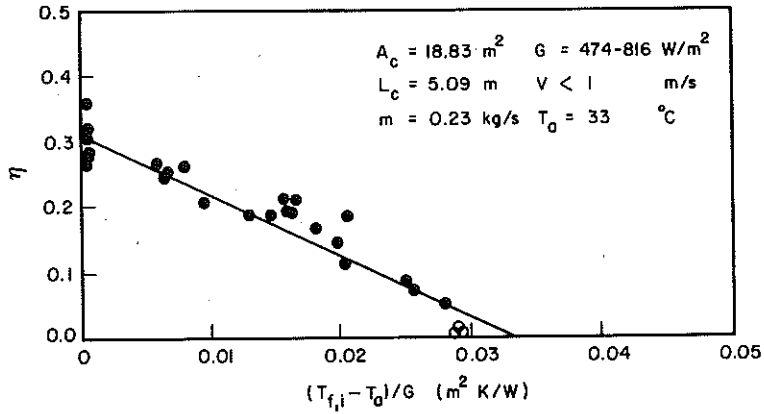

Fig. 15. Test result of bare flat-plate solar air heater with dull black painting.

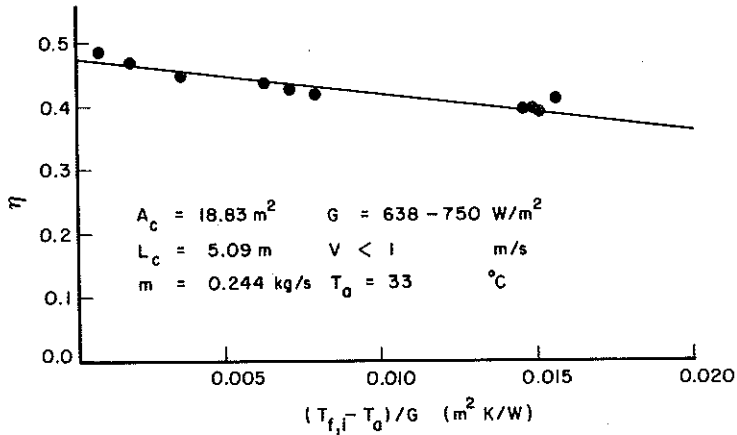

Fig. 16. Test result of partial glass-cover (85%) flat-plate solar air heater having sinusoidal corrugated galvanized iron sheet.

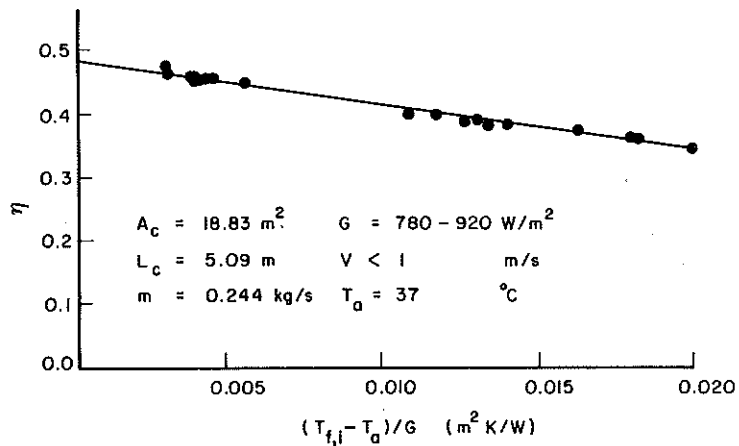

Fig. 17. Test result of partial glass-cover (87.5%) flat-plate solar air heater having trapezoidal corrugated galvanized iron sheet.

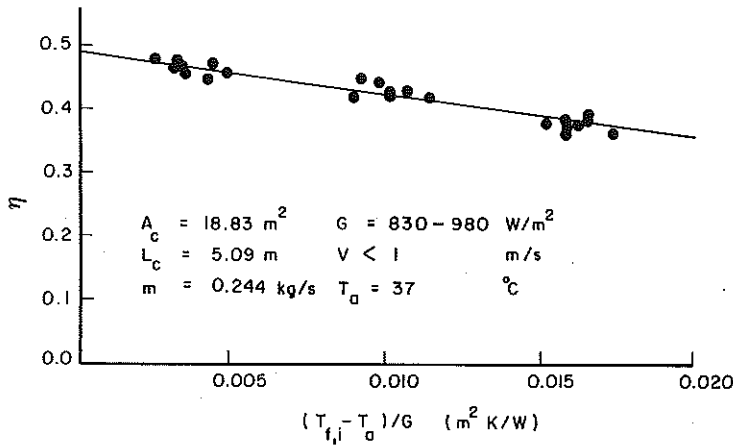

Fig. 18. Test result of full glass-cover flat-plate solar air heater having trapezoidal corrugated galvanized iron sheet.

would have been more obvious. The points on the graphs of bare plate solar air heaters were relatively scattered. This was due to the effect of wind speed which was significant in bare plate solar air heaters.

Performance curves for all types of solar air heater are drawn together in Fig. 19. Type 2 had better efficiency at low inlet air temperature but lower efficiency at higher inlet temperature or $(T_{f,i} - T_a)/G$ when compared to type 1. At high inlet temperature, type 2 which had dull black absorber was subject to higher radiative loss due to higher emissivity though it absorbed more solar radiation. It should be noted that mass flow rate of type 1 was about 50% higher. If it had been equal to type 2, its thermal efficiency would have dropped a few percent.

Solar air heaters with a clear glass cover had much better performance than those of bare plate solar air heaters. This was due to less heat loss. Type 5 had performed somewhat better than type 4 because its absorber was fully covered with clear glass while the absorber of type 4 was 87.5% covered (both have a trapezoidal shape). Type 3 had an absorber having sinusoidal shape and was 85% covered with clear glass sheets. At low inlet air temperature, the efficiency was

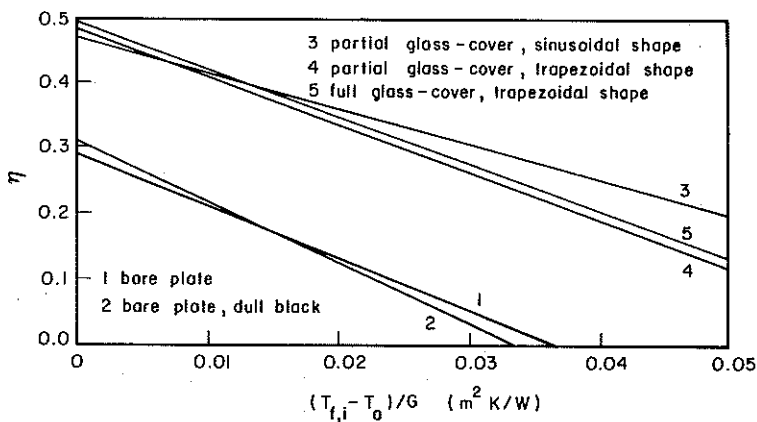

Fig. 19. Comparison of experimental thermal efficiency of flat-plate solar air heaters.

lower than types 4 and 5 but it was higher when the inlet temperature was high enough. The difference was however not very obvious. It was still inconclusive.

Simulation Study of Solar Air Heaters

The mathematical model developed in the previous section was used to predict steady state performance of solar air heaters. Table 2 summarizes comparative results between experiment and simulation for all types of solar air heater. Figures 20 and 21 show the comparison for types 1 and 5. It was concluded that the mathematical models were relatively accurate for predicting steady state performance of flat-plate solar air heaters.

Table 2. Comparative collector performance between experiment and simulation.

Type	\dot{m} (kg/s)	Experiment		Simulation	
		$F_R (\tau\alpha)_a$	$-F_R U_L$ (W/m ² K)	$F_R (\tau\alpha)_a$	$-F_R U_L$ (W/m ² K)
1	0.34	0.29	-7.96	0.29	- 7.10
2	0.23	0.32	-9.34	0.34	-10.50
3	0.24	0.47	-5.50	0.47	- 4.70
4	0.24	0.48	-7.25	0.48	- 4.48
5	0.24	0.49	-7.13	0.49	- 4.26

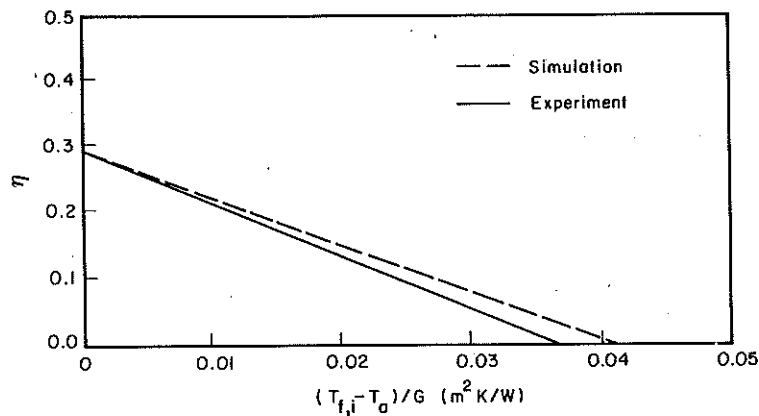

Fig. 20. Comparison between experimental and simulated efficiencies of bare flat-plate solar air heater without painting.

The effect of air speed in solar air heaters and wind speed above collectors was investigated by mathematical simulation. Figures 22 and 23 show the simulated results relating F_R or efficiency and air speed for constant wind speed, for solar air heaters types 1 and 5, respectively. For both types, efficiency increased rapidly when air speed is small and increased slowly when air speed is high, at constant wind speed. The same result was also found for F_R . From Fig. 22, it

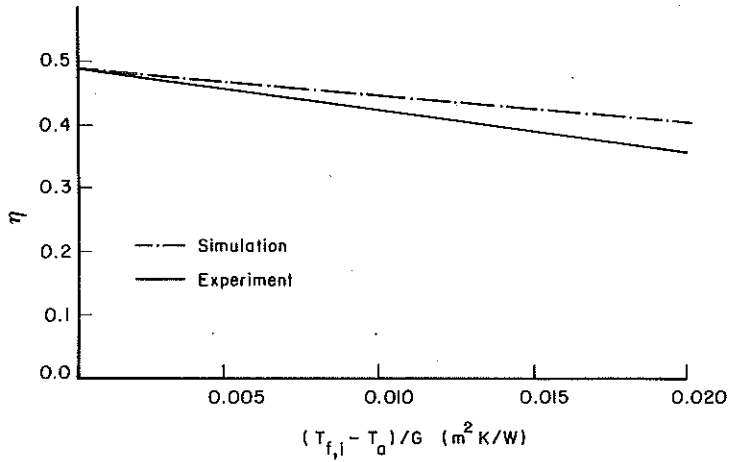

Fig. 21 Comparison between experimental and simulated efficiencies of glass-cover flat-plate solar air heater.

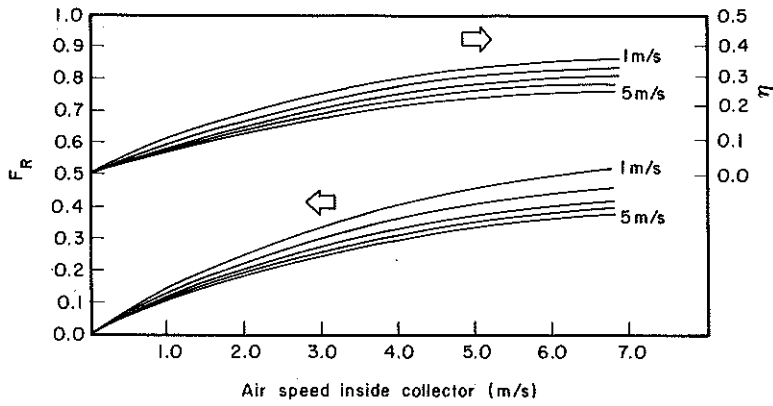

Fig. 22. Effect of air speed inside collector and wind speed above collector on F_R and thermal efficiency of bare flat-plate solar air heater. (Wind speed varies from 1 to 5 m/s from the top to bottom curves.)

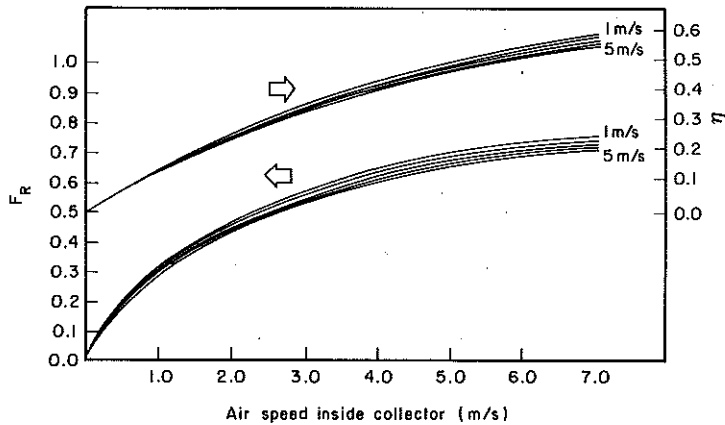

Fig. 23 Effect of air speed inside collector and wind speed above collector on F_R and thermal efficiency of glass-cover flat-plate solar air heater. (Wind speed varies from 1 to 5 m/s from the top to bottom curves.)

was obvious that wind speed above solar air heater was important for the performance of bare plate solar air heaters. The efficiency dropped rapidly when wind speed increased. For solar air heaters having glass cover, the effect of wind speed was much less important.

Guidelines for Selecting Solar Air Heaters and Air Speed

Bare flat-plate solar air heaters may be appropriate particularly for regions having low wind speeds; however, their efficiency is relatively low. This is compensated for by ease of construction and low initial investment costs. Air speed inside solar air heaters should be around 4-6 m/s. This corresponds to the specific air flow rate of 0.015-0.023 kg/s per m² of the solar collector area. Lower air speed will result in low efficiency but higher air speed may result in an excessive pressure drop inside the solar air heater.

Transparent-cover flat-plate solar air heaters are appropriate for all regions having low or high wind speeds. Air speed should be around 4-6 m/s.

ECONOMIC ANALYSIS

An economic analysis of three types of solar air heater namely type 1, type 2 and type 3 was conducted. The amount of energy saved by solar air heaters was calculated by using collector test data at a mass flow rate of 0.24 kg/s. It was then compared to conventional energy such as electricity, LPG, diesel oil and fuel oil. The following assumptions were made:

1. Initial investments for type 1, type 2 and type 3 were 6,800; 7,700 and 12,600 Baht, respectively. (collector area = 19 m²)
2. Salvage value was 10 % of initial investment.
3. Maintenance was 500 Baht per year and cost of electricity for driving fan was 400 Baht per year if solar air heaters were operated 8 months per year (8 h/day).
4. Service life was 8, 10 and 12 years for type 1, type 2, and type 3, respectively.
5. Interest rate was 15% per annum.
6. Unit cost of conventional energy was assumed to be 0.36, 0.69, 0.80 and 1.24 Baht per kWh for fuel oil, diesel oil, LPG, and electricity, respectively.
7. Average solar radiation was 16.7 MJ/m² per day.

Table 3 shows energy cost according to various types of solar air heater. Type 3 gave lowest energy cost. When period of operation was 6 months per year, energy cost of all solar air heater

Table 3. Energy cost of solar air heaters (Baht/kWh).

Period of Operation (month/year)	Type 1	Type 2	Type 3
2	1.71	1.29	0.71
4	0.90	0.68	0.61
6	0.63	0.47	0.42
8	0.49	0.37	0.32
10	0.41	0.31	0.27

was lower than the cost of electricity, LPG, and diesel oil but still higher than the cost of fuel oil. Type 3 gave energy cost lower than fuel oil when operation was 8 months per year.

If the system was operated 8 months per year, payback period and internal rate of return when compared to several conventional energy costs were determined as shown in Tables 4 and 5. Both types 2 and 3 had approximately the same payback period when compared to electricity, LPG, and diesel oil but type 3 was better when compared to fuel oil. Both had payback period less than that of type 1. Considering internal rate of return, types 2 and 3 had approximately the same internal rate of return except when compared to fuel oil when type 3 was better. Both types had higher internal rate of return than that of type 1.

Table 4. Payback period (year) of solar air heaters.

When Compared to	Type 1	Type 2	Type 3
Electricity	1.46	1.14	1.19
LPG	2.77	2.04	2.06
Diesel oil	3.58	2.54	2.53
Fuel oil	-	-	8.38

Table 5. Internal rate of return (%) of solar air heaters.

When Compared to	Type 1	Type 2	Type 3
Electricity	72.1	93.0	90.0
LPG	41.1	55.3	55.2
Diesel oil	32.3	45.7	46.4
Fuel oil	-	-	20.2

When interest rate varied from 5 to 29%, energy cost of types 1, 2, and 3 varied from 0.389-0.649, 0.281-0.507, and 0.277-0.478 Baht/kWh, respectively, and payback period of types 1, 2, and 3 when compared with electricity varied from 1.28-1.77, 1.02-1.34, and 1.06-1.41 years, respectively. The results indicated high economic potential.

Figure 24 shows the economic potential, compared to electricity, of type 3 when the initial cost increased from 1 to 5 times. When the initial cost was 4 times higher, payback period increased to about 3 years. This indicated that investing in flat-plate solar air heaters is quite attractive.

CONCLUSIONS

1. Use of bare flat-plate solar air heaters was technically viable. Wind speed above solar air heater should not be high. Air speed inside solar air heater should be around 4-6 m/s. This corresponds to the specific air flow rate of 0.015-0.023 kg/s per m² of the solar collector area.

2. Use of transparent-cover flat-plate solar air heaters was also technically viable with much greater efficiency. They could be used in areas where wind speed was high or low. Air speed

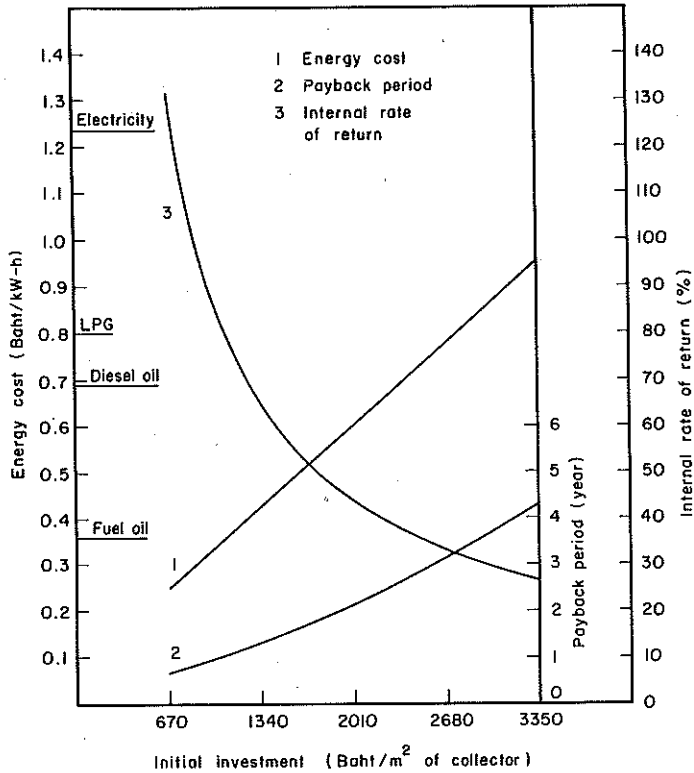

Fig. 24. Energy cost, payback period, and internal rate of return when compared to electricity, as a function of initial cost of glass-cover flat-plate solar air heater.

should be also around 4-6 m/s.

3. The mathematical model developed for flat-plate solar air heaters was for steady state conditions and was accurate enough for predicting thermal efficiency.

4. Economic analysis indicated that there was a high potential for acceptance particularly when compared to electricity. It could not, however, compete with fuel oil.

ACKNOWLEDGEMENT

The authors would like to thank the USAID for financial support under the Renewable Nonconventional Energy Project, Royal Thai Government and U.S. Agency for International Development.

REFERENCES

Anon (1977), *ASHRAE Standard 93-77, Methods of Testing to Determine the Thermal Performance of Solar Collectors*, ASHRAE, New York.

- Anon (1986), Solar Drying in ASEAN Countries, *RAPA Publication: 1986/27*, FAO, Bangkok, pp.2-3.
- Boonlong, P. et al. (1984), Solar-assisted Tobacco Curing, Paper presented at the *Regional Seminar on Solar Drying*, Yogyakarta, Indonesia, 28-30 August.
- Duffie, J.A. and W.A. Beckman (1980), *Solar Engineering of Thermal Processes*, John Wiley and Sons.
- Exell, R.H.B. (1980), Basic Design Theory for a Simple Solar Rice Dryer, *Renewable Energy Review Journal*, Vol. 1, No. 2., pp.1-14.
- Foster, G.H. and R.M. Peart (1976), Solar Grain Drying: Progress and Potential, *Agricultural Information Bulletin No. 401*, U.S.D.A.
- Patranon, R. (1984), *Solar Thermal Processes in Thailand: A Study on Natural Convection Cabinet Drying*, Final report, USAID-Thai Renewable Non-conventional Energy Co-operation Project, KMITT.
- Sitthiphong, N. et al. (1987), *Large-scale Solar-assisted Multiple-crop Dryers*, Department of Mechanical Engineering, Chiang Mai University, Chiang Mai 50002, Thailand.
- Soponronnarit, S. and A. Peyre (1982), Low Temperature Sorghum Drying in the South of France, *Proceedings of the 3rd International Drying Symposium, Volume 1*, edited by J.C. Ashworth, Birmingham.
- Soponronnarit, S. (1988), Review of Research and Development Work on Forced Convection Solar Drying in Thailand, *RERIC International Energy Journal*, Vol. 10, No. 1, pp.19-27.
- Thaina, S. (1979), *A Cabinet Solar Dryer*, Master Thesis, King Mongkut's Institute of Technology Thonburi, Bangkok. (in Thai)
- Thongprasert, S. et al. (1985), *An Economic Study on Solar Rice Dryer*, Final report submitted to National Energy Administration, Bangkok. (in Thai)
- Watmuff, J.H., W.W.S. Charters and D. Proctor (1977), *Solar and Wind Induced External Coefficients of Solar Collectors*, Comple, 2.